

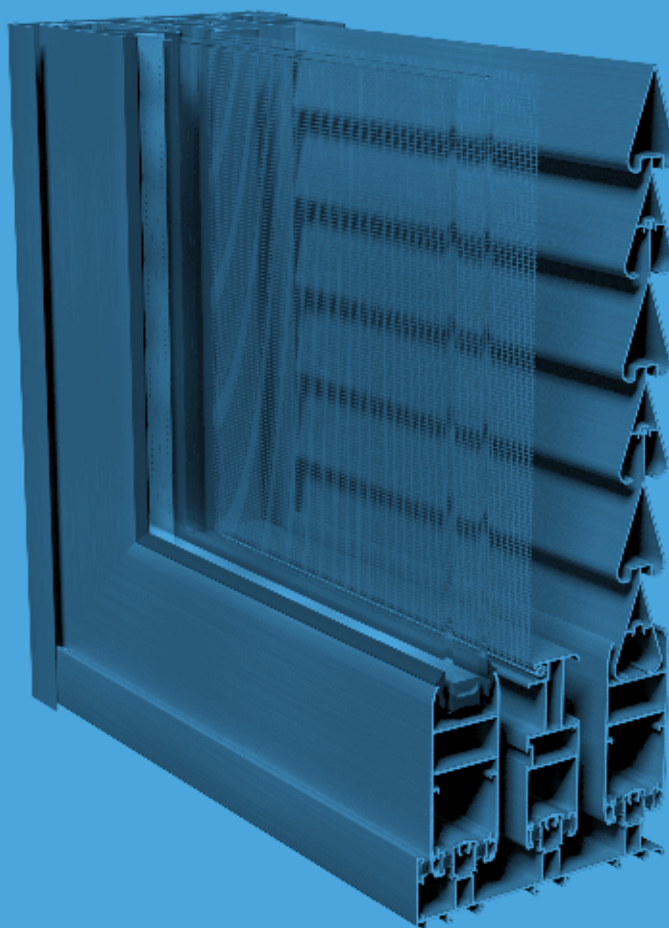

## SLIDING SYSTEM СИСТЕМА С ОТВАРЯНЕ ТИП ПЛЪЗГАНЕ

- Wide variety of profiles
  - Modular construction, enabling addition of new configurations over an existing structure
  - Options to use all types of combinations - single glass, glazing, sliding shutters - sun protection screens, insect screens
- 
- Богато разнообразие от профили
    - Модулна конструкция, позволяваща добавяне на нови конфигурации върху съществуваща конструкция
    - Възможност за изпълнение на всички познати видове отваряне и пълнежи - единично стъкло, стъклопакет, плъзгащи се капаци - слънцезащитни пана, противонасекомни или защитни мрежи

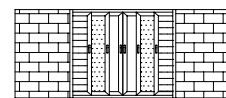

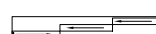
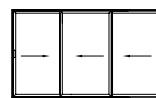
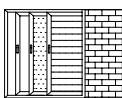
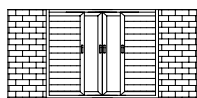
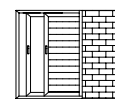
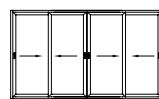
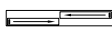
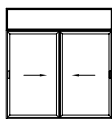
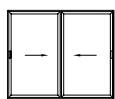
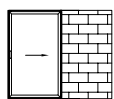

## certificates

## сертификати

- **Certificate for air permeability, watertightness and resistance to wind load, issued by EKANAL:**

- air permeability – class 3
- watertightness – class 4A
- resistance to wind load – class C4

- **Certificates for sound insulation:**





- 22 mm (6/12/4) – R w = 36 dB
- 22 mm (4/14/4) – R w = 34 dB

- **Сертификат за въздухопропускливост, водонепропускливост и устойчивост на вятър, издаден от EKANAL:**

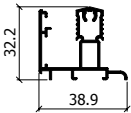
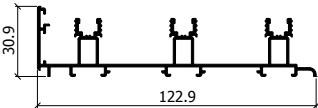
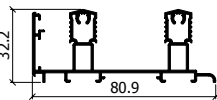

- въздухопропускливост – клас 3
- водонепропускливост – клас 4A
- устойчивост на вятър – клас C4

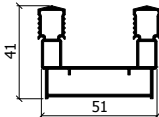
- **Сертификати за шумоизолация:**

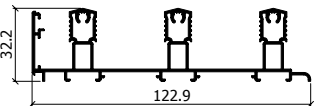
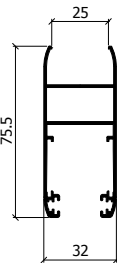
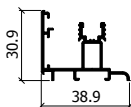
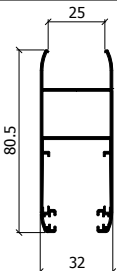
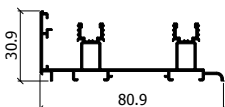
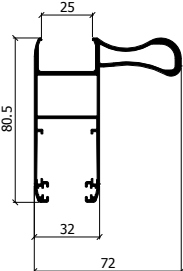
- 22 мм (6/12/4) – R w = 36 dB
- 22 мм (4/14/4) – R w = 34 dB

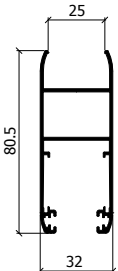
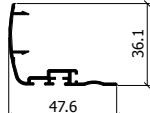
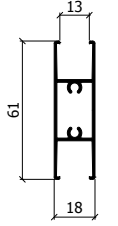
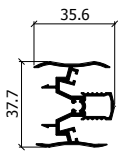
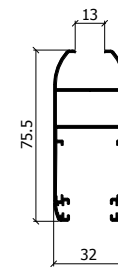
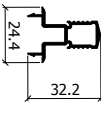
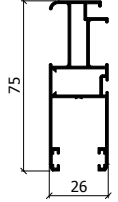
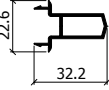
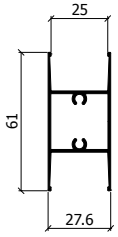
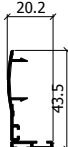
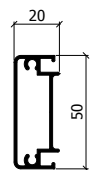
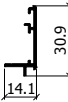
CODE	profile профил	weight length moment of inertia	CODE	profile профил	weight length moment of inertia
<b>E 19100</b>		540 g/m L= 6.01 m Jx=2.07 cm <sup>4</sup> Jy=2.35 cm <sup>4</sup>	<b>E 19108</b>		1150 g/m L= 6.01 m Jx=2.72 cm <sup>4</sup> Jy=62.84 cm <sup>4</sup>
<b>E 19101</b>		961 g/m L= 6.01 m Jx=3.76 cm <sup>4</sup> Jy=22.17 cm <sup>4</sup>	<b>E 19602</b> inox		265 g/m L= 6.01 m
<b>E 19121</b>		847 g/m L= 6.01 m Jx=5.13 cm <sup>4</sup> Jy=11.42 cm <sup>4</sup>	<b>E 19900</b>		162 g/m L= 6.01 m
<b>E 19102</b>		1385 g/m L= 6.01 m Jx=5.44 cm <sup>4</sup> Jy=73.48 cm <sup>4</sup>	<b>E 19201</b>		863 g/m L= 6.01 m Jx=15.08 cm <sup>4</sup> Jy=5.74 cm <sup>4</sup>
<b>E 19106</b>		462 g/m L= 6.01 m Jx=1.24 cm <sup>4</sup> Jy=2.2cm <sup>4</sup>	<b>E 19202</b>		1150 g/m L= 6.01 m Jx=18.02 cm <sup>4</sup> Jy=6.03 cm <sup>4</sup>
<b>E 19107</b>		807 g/m L= 6.01 m Jx=1.98 cm <sup>4</sup> Jy=19.26 cm <sup>4</sup>	<b>E 19204</b>		1150 g/m L= 6.01 m Jx=33.5 cm <sup>4</sup> Jy=29.57 cm <sup>4</sup>

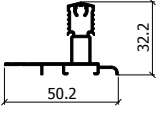
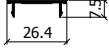
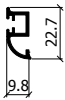
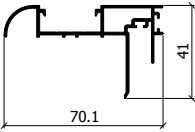
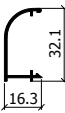
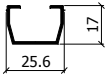
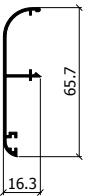
CODE	profile профил	weight length moment of inertia	CODE	profile профил	weight length moment of inertia
<b>E 19205</b>		956 g/m L= 6.01 m $J_x=19.34 \text{ cm}^4$ $J_y=6.41 \text{ cm}^4$	<b>E 19501</b>		370 g/m L=4.8 m $J_x=1.51 \text{ cm}^4$ $J_y=2.48 \text{ cm}^4$
<b>E 19300</b>		575 g/m L= 6.01 m $J_x=5.61 \text{ cm}^4$ $J_y=1.12 \text{ cm}^4$	<b>E 19510</b>		373 g/m L= 4.8 m $J_x=3.5 \text{ cm}^4$ $J_y=1.64 \text{ cm}^4$
<b>E 19200</b>		884 g/m L= 6.01 m $J_x=16.1 \text{ cm}^4$ $J_y=5.6 \text{ cm}^4$	<b>E 19511</b>		310 g/m L= 4.8 m $J_x=0.36 \text{ cm}^4$ $J_y=21.99 \text{ cm}^4$
<b>E 22215</b>		857 g/m L= 6.01 m $J_x=16.3 \text{ cm}^4$ $J_y=2.7 \text{ cm}^4$	<b>E 19512</b>		284 g/m L= 4.8 m $J_x=0.32 \text{ cm}^4$ $J_y=0.9 \text{ cm}^4$
<b>E 19301</b>		602 g/m L= 6.01 m $J_x=5.11 \text{ cm}^4$ $J_y=2.69 \text{ cm}^4$	<b>E 19514</b>		280 g/m L=4.8 m $J_x=2.02 \text{ cm}^4$ $J_y=0.29 \text{ cm}^4$
<b>E 22214</b>		590 g/m L= 6.01 m $J_x=6.93 \text{ cm}^4$ $J_y=0.93 \text{ cm}^4$	<b>E 19600</b>		180 g/m L= 6.01 m $J_x=0.58 \text{ cm}^4$ $J_y=0.08 \text{ cm}^4$

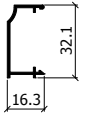
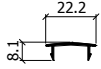
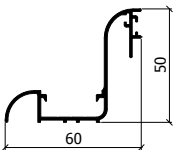
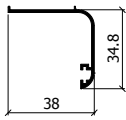
CODE	profile профил	weight length moment of inertia	CODE	profile профил	weight length moment of inertia
<b>E 19601</b>		896 g/m L= 6.01 m $J_x=1.85 \text{ cm}^4$ $J_y=1.93 \text{ cm}^4$	<b>E 19641</b>		130 g/m L= 4.8 m
<b>E 19610</b>		191 g/m L= 6.01 m	<b>E 19642</b>		665 g/m L= 6.01 m
<b>E 19620</b>		194 g/m L= 6.01 m	<b>E 19643</b>		186 g/m L= 6.01 m
<b>E 19621</b>		343 g/m L= 6.01 m	<b>E 19650</b>		103 g/m L= 6.01 m
<b>E 19622</b>		205 g/m L= 6.01 m	<b>E 19651</b>		100 g/m L= 4.8 m
<b>E 19640</b>		562 g/m L= 6.01 m	<b>E 5366</b>		269 g/m L= 6.01 m

sliding system  
система с отваряне тип плъзгане

**E 19**

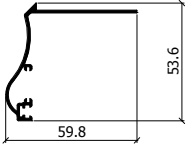
CODE	profile профил	weight length moment of inertia	CODE	profile профил	weight length moment of inertia
<b>E 5367</b>		467 g/m L= 6.01 m			

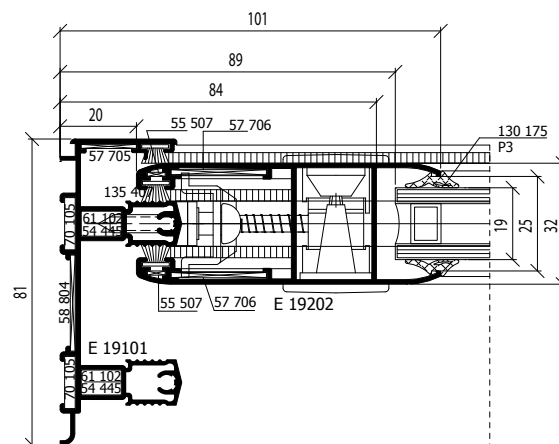
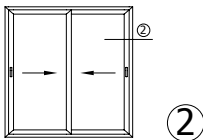
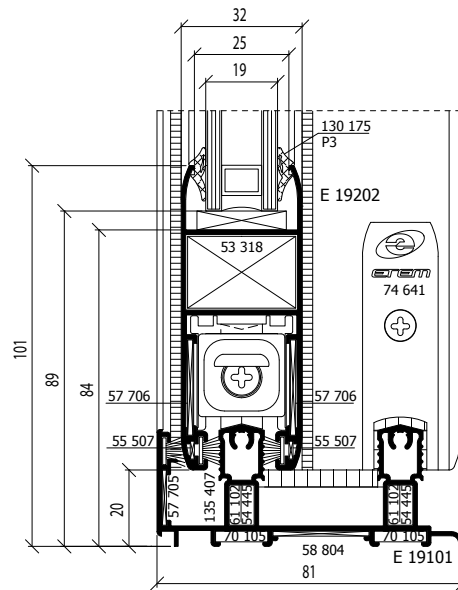
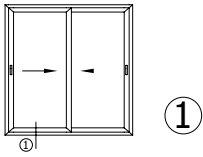

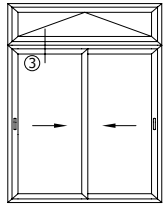

3

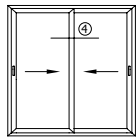
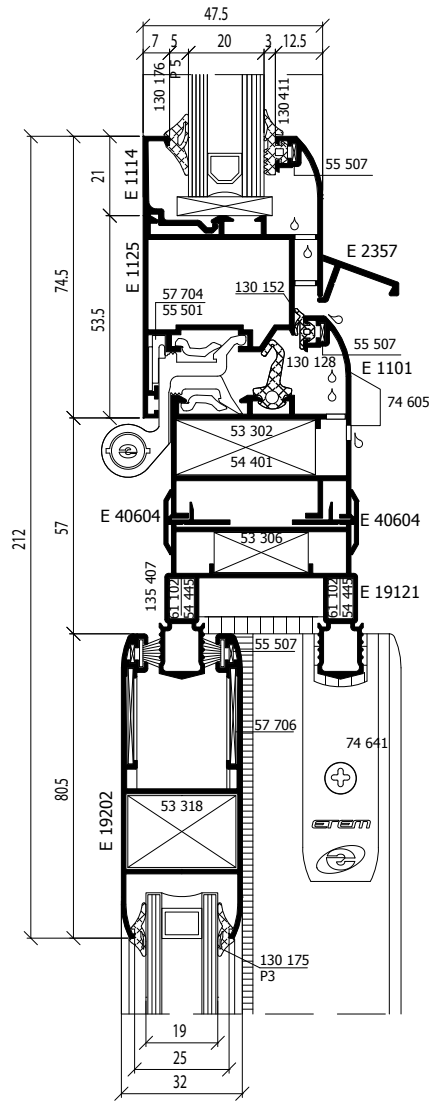

4

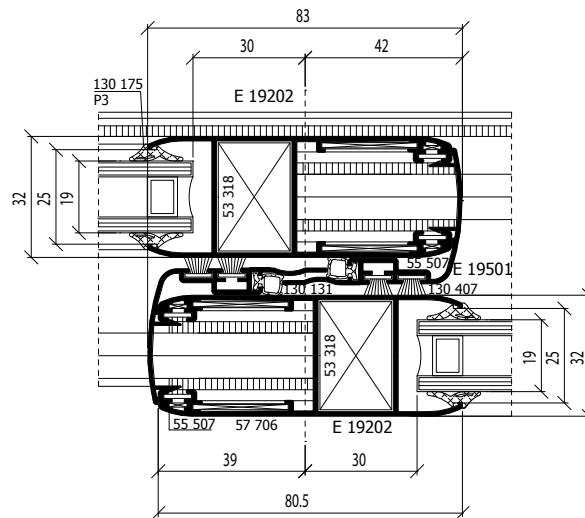

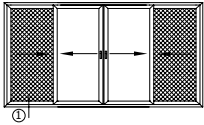

①

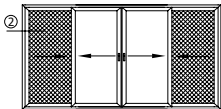
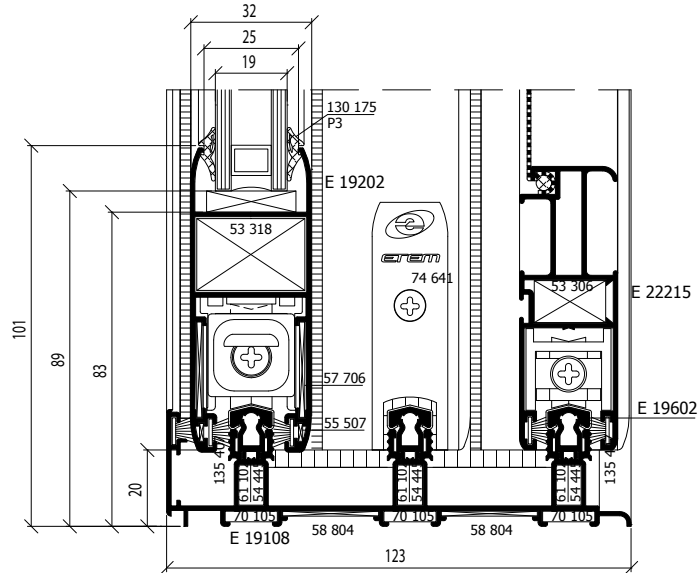

②

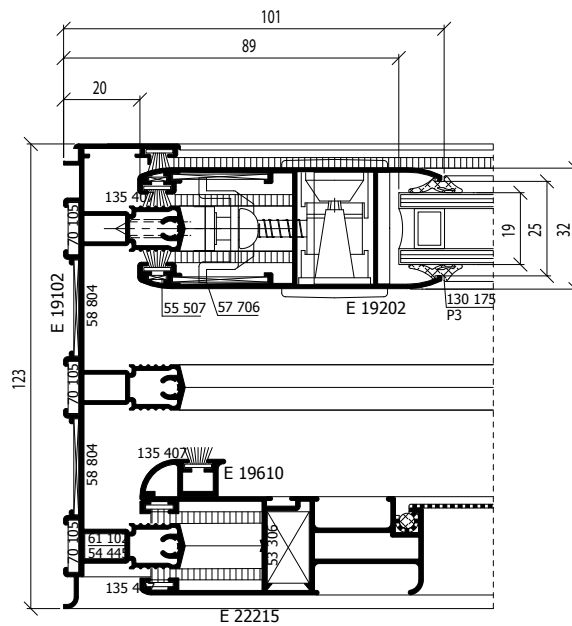

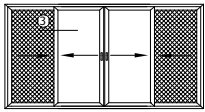



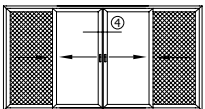
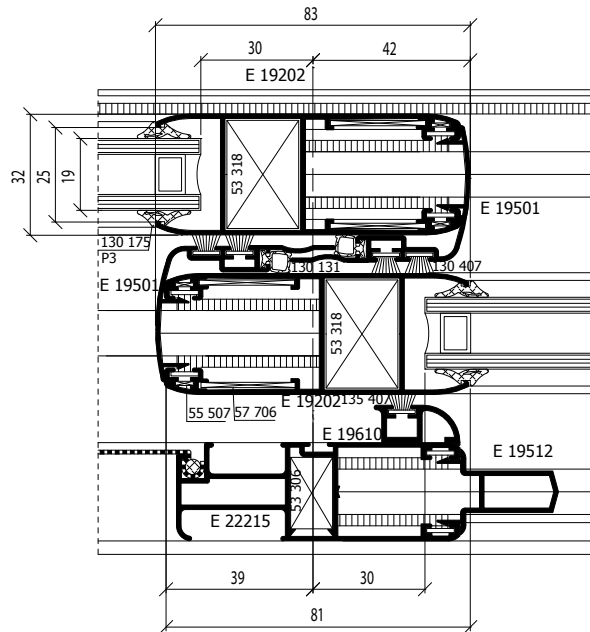



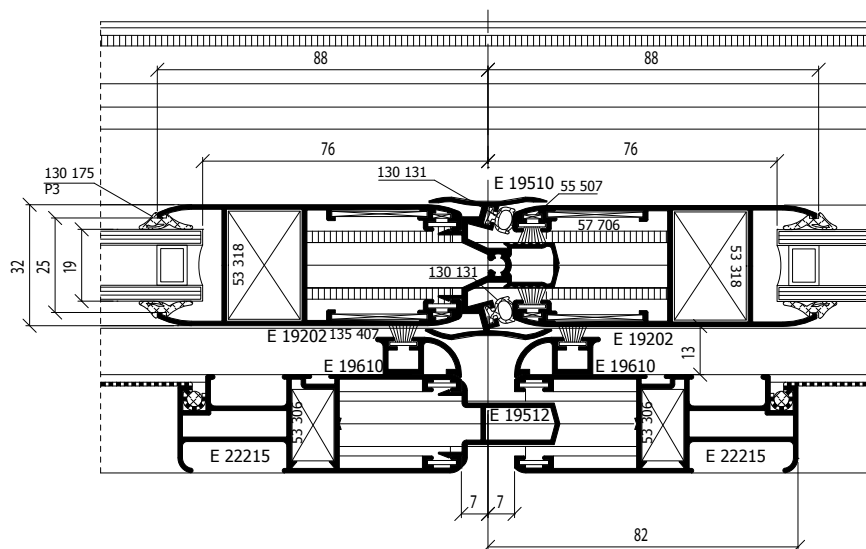





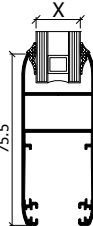
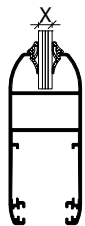

③



④

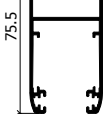
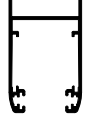

GLAZING OPTIONS / ОСТЪКЛИТЕЛНА ТАБЛИЦА

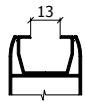
GASKETS FOR GLAZING BEADS / УПЛЪТНИТЕЛИ							SASHES / КРИЛА	
2x 	3 - 4 mm 130 175	2x 	5 - 6 mm 130 176	2x 	7 - 8 mm 130 177		<b>E 19201</b> 	<b>E 19200</b> 
2x 3 mm P3 	2x 4 mm P4 	2x 5 mm P5 	2x 6 mm P6 	2x 7 mm P7 	2x 8 mm P8 	2x 10 mm P10 		
X mm								
19	17	15	13	11	9	5	<b>E 19201</b> 	
7	5	-	-	-	-	-	<b>E 19201 + E 19643</b> 	<b>E 19200</b> 